

The durable Truper foot was designed to take on the toughest of childhood challenges by combining stability and dynamic response. The foot stores and releases energy while in use, allowing for a smooth and controlled transition from standing to running. The inversion/eversion and superior transverse rotation provides exceptional ground compliance; improving performance and stability, whether walking or running.

The foot is available in two size ranges, which allows the foot size to be increased simply by purchasing the next size foot shell and sole plate, making it a cost-effective and flexible solution for a growing child.

Note: Sizes 16-18cm are supplied with blue ankle and sizes 19-21cm are supplied with a purple ankle

Features and Benefits

- Versatile finishing capability
- Sandal toe design allows for a choice of shoes
- Reduces fatigue and protects the residual limb
- Adjustable Stride Control™ to customise child's gait
- Sealing boot interlocks with the foot shell to prevent any debris from entering the foot



Cosmetics



Ordering Information

There is a 30-day trial period on this foot.

Includes - Foot shell, CPI Spectra Sock and sealing boot.

Impact Level Descriptions

High: Daily activities include fast walking, jogging, running, lifting heavy objects and/or recreational sports.

Ordering Example - NTP-LBEN-16-G2

Part ID	Side	Shell Colour	Mounting	Size	Firmness Category
NTP	L/R				G

Caucasian	C	Endo	EN	16-21cm	1-3
Tan	T	Exo*	ALX		
Brown	B				

Weight (kg)	0-22	23-33	34-45	46-60
Size (cm)		16-21		19-21
High Impact	1	2	3	3

*Please note: The Exo Ankle Block does not come with the foot. This will need to be ordered separately - see page 324 for ordering information.

Foot Shell Ordering Information

Foot Shell	Size (cm)	Shell
NTP-S ■ ● -▲	16-21	S
NTP-XS ■ ● -▲	16-21	XS*



Shelltread	Size (cm)
NTP-T ■ N-▲	16-21



*Exo only, add 1 day for processing.

◆ = "L" or "R" for Left or Right

■ = Colour (C = Caucasian, B = Brown, T = Tan)

● = Foot size in cm (16-21)

■ = "L" or "R" for Left or Right

● = Colour (C = Caucasian, B = Brown, T = Tan)

▲ = Foot size in cm (16-21)

Neutral

Product Specification

Mounting	Sizes	Weight Limit	Impact Level	Weight	Build Height	Warranty	Foot Shell
Endo (IP)	16-21cm	45kg (16-18cm)	M H	215g (size 16)	5.3-6.1cm (Endo IP)	1 year Foot shell - 6 months	C T B Standard width Caucasian, Tan or Brown
Exo (ALX)		60kg (19-21cm)		314g (size 21)	11-11.8cm (Endo ALX)		

Technical Information

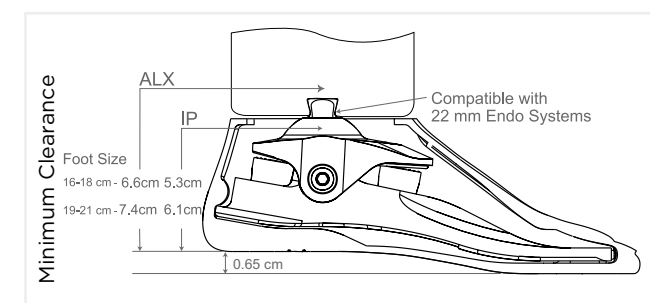

Gait Match	Front Bumper	Ankle Bushings	Rear Bumper
Firmness Category 1	S	One Firmness	S
Firmness Category 2	M		M
Firmness Category 3	F		F

Note: Please see the following page for Truper spare parts ordering information.

Spare Parts Ordering Information

Bumpers & Bushings	Description	Bumper Colour
NTP-BS-1618	Bumper, Soft, 16-18cm	S
NTP-BS-1921	Bumper, Soft, 19-21cm	S
NTP-BM-1618	Bumper, Medium, 16-18cm	M
NTP-BM-1921	Bumper, Medium, 19-21cm	M
NTP-BF-1618	Bumper, Firm, 16-18cm	F
NTP-BF-1921	Bumper, Firm, 19-21cm	F
NTP-ABM-1618	Ankle Bushing, 16-18cm	-
NTP-ABM-1921	Ankle Bushing, 19-21cm	-

S Soft M Medium F Firm EF Extra Firm

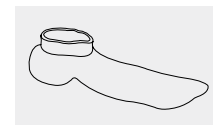

CPI Spectra Sock	Size (cm)
NTP-SS-1621	16-21
NTP-SSX-1618	16-18 (Exo)

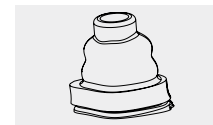

Sealing Boot	Size (cm)
NTP-SB ■●-1618	16-18
NTP-SB ■●-1921	19-21

■ = "L" or "R" for Left or Right
● = Colour (C = Caucasian, B = Brown, T = Tan)



Endo Ankle	Size
NTP-ENA-1618	Endo Ankle, 16-18cm
NTP-ENA-1921	Endo Ankle, 19-21cm

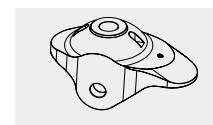

Exo Ankle	Size
NTP-ALXA-1618	Exo Ankle, 16-18cm
NTP-ALXA-1921	Exo Ankle, 19-21cm



Foreheel	Description
NTP-FHA ■▲	Foreheel

■ = "L" or "R" for Left or Right
▲ = Foot size in cm (16-21)

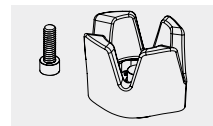

Includes Mounting Bolt

Exo Block Kit	Description
NTP-XBK ■-1618	Alignable Exo Block Kit, 16-18cm
NTP-XBK ■-1921	Alignable Exo Block Kit, 19-21cm

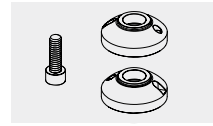

Includes 2 Growth Plates, Mounting Bolt and Finishing Ring

Part Number	Description
NTP-GK ■ C-1618	Growth Plate Kit, Caucasian, 16-18cm
NTP-GK ■ B-1618	Growth Plate Kit, Brown, 16-18cm
NTP-GK ■ C-1921	Growth Plate Kit, Caucasian, 19-21cm
NTP-GK ■ B-1921	Growth Plate Kit, Brown, 19-21cm
NTP-GP-1618	Growth Plate, 16-18cm
NTP-GP-1921	Growth Plate, 19-21cm

■ = "L" or "R" for Left or Right

Growth Range

Weight Limit	
45Kg	60kg
18cm	21cm
17cm	20cm
16cm	19cm

The Truper offers two growth ranges, 16-18cm and 19-21cm, and additional exoskeletal growth plates adding 2cm in height.

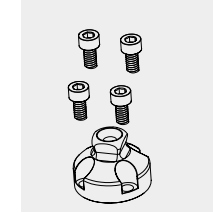

Part Number	Description
NTP-EXPK-22	Exo Pyramid Tool Kit, 22mm* *For temporary endoskeletal alignment during test fittings

Exo Mounting Blocks	Description	Application
NTP-SH-5X10	Exo Mounting Bolt, M5 x 10mm	Standard exo mounting bolt to attach an exo foot to the exo block
NTP-SH-8X16	Exo Mounting Bolt, M8 x 16mm	Used if one growth plate is being used with the exo block
NTP-SH-8X30	Exo Mounting Bolt, M8 x 30mm	Used if there are two growth plates being used with the exo block

Finishing Rings		
Left	Right	Description
NTP-FRLC-1618	NTP-FRRC-1618	Caucasian, 16-18cm
NTP-FRLC-1921	NTP-FRRC-1921	Caucasian, 19-21cm
NTP-FRLB-1618	NTP-FRRB-1618	Brown, 16-18cm
NTP-FRLB-1921	NTP-FRRB-1921	Brown, 19-21cm

Hardware	Description
NTP-AP-1618	Axial Pin, 16-18cm
NTP-AP-1921	Axial Pin, 19-21cm
NCP-APS	Axial Pin Screw
NTP-RBK	Pyramid Tool Retaining Bolt Kit (4pc) M5 x 10mm
NTP-DP-4X12	Dowel Pin, M4 x 12mm
NTP-DP-4X8	Dowel Pin, M4 x 8mm

